

SOMERSET

Tel: 978.667.3355

800.772.4404

Fax: 978.671.9466

Email: somerset@smrset.com

www.smrset.com

SPM-45

PASTRY & TURNOVER MACHINE

**FOLDS! CRIMPS! TRIMS!
SEALS! ALL IN ONE
OPERATION! UP TO
800 PIECES AN HOUR!**

IDEAL FOR

- Beerocks
- Boeregs
- Calzones
- Caribbean Patties
- Chilean Saltenas
- Empadas
- Empanadas
- Empanadillas
- Fried Pies
- Fruit Pies
- Jamaican Patties
- Lahmajoons
- Panzarottis
- Pattie Cakes
- Pastries
- Pierogies
- Pieroshkis
- Pot Stickers
- Samosas
- Sanbusak
- Spinach Pie
- Strombolis
- Texas Meat Pies
- Turnovers



The SPM-45 is a simple hand operated machine which can create big profits for your business. It can make a wide range of different products by simply changing the dies. All finished products will have a perfect seal with no need to brush the edges with egg wash or other sealants.

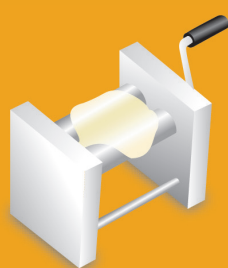

1. Place dough on die

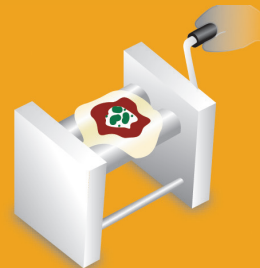

2. Add filling and rotate handle 1/2 turn

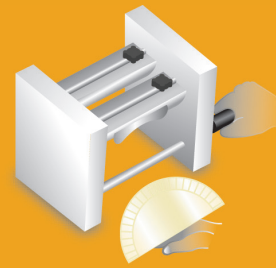

3. Finished product drops at bottom



- Compact design, simple, easy to clean
- Guaranteed savings on dough and fillings
- Perfect dough seal translates to oil savings on fried products
- Enhances appearance and consistency of finished products
- Increase production (up to 500 pieces per hour)
- Custom designed dies available
- Wide selection of dies in various shapes

SOMERSET INDUSTRIES, INC • 1 ESQUIRE ROAD • NORTH BILLERICA, MA 01862 • U.S.A.

SOMERSET

PASTRY & TURNOVER MACHINE

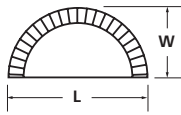

HALF ROUND

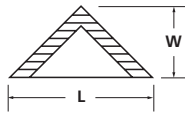

TRIANGULAR

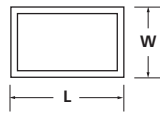

RECTANGLE

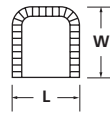

SQUARE

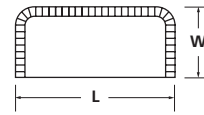

ROUNDED RECTANGLE

DIE SELECTION LIST (CUSTOM DESIGNED DIES AVAILABLE)

	MODEL	LENGTH (L)		WIDTH (W)		HEIGHT (H)	
	DD1	2.50"	63mm	1.13"	29mm	1.00"	25mm
	DS1	3.50"	89mm	1.75"	45mm	1.25"	32mm
	DS3	4.50"	114mm	2.50"	64mm	1.50"	38mm
	DS5	5.00"	127mm	3.00"	76mm	1.50"	38mm
	DS8	5.50"	140mm	3.25"	83mm	2.00"	51mm
	DS11	6.75"	171mm	3.25"	83mm	1.75"	45mm
	DS12	6.375"	160mm	3.25"	83mm	1.25"	32mm
	DS13	7.25"	184mm	3.50"	89mm	2.00"	51mm
	DS15	8.00"	203mm	4.00"	102mm	2.50"	64mm
	DS17	9.00"	230mm	3.50"	89mm	2.25"	57mm
	SD1	2.75"	70mm	1.75"	45mm	1.00"	25mm
	RS1	4.50"	114mm	2.38"	60mm	1.00"	25mm
	RS2	7.25"	184mm	2.00"	51mm	1.00"	25mm
	RS3	7.50"	190mm	2.50"	64mm	1.75"	45mm
	JS1	4.50"	114mm	3.25"	83mm	1.25"	32mm
	TS1	5.00"	127mm	2.75"	70mm	1.00"	25mm
	SM2	2.38"	60mm	1.38"	35mm	0.75"	19mm
	SM4	3.75"	95mm	2.25"	57mm	1.25"	32mm
	SM6	4.50"	114mm	3.50"	89mm	0.75"	19mm

- Bakeries
- Restaurants
- Pizzerias
- Cafes
- Institutions
- Schools
- Other ethnic food production

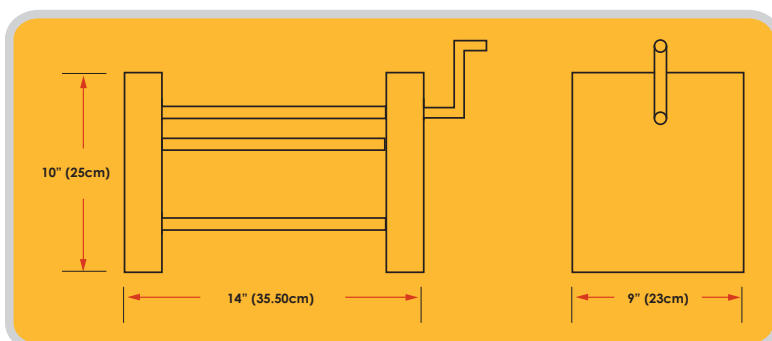

SPECIFICATIONS

(Specifications subject to change without notice)

Finish: All Stainless Steel

Shipping Weight: 30 lbs (15 kgs)



APPROVED

MADE IN THE U.S.A. 05.10.12