

TABLE TOP SHEETERS **EMP-EASY**



EMP-Easy750

Maximum Versatility, Compact Design

Empire's Table Top Dough & Pastry Sheeters are the ultimate multi-tasking tool for your bakery. They are ideal for laminated dough, pie crusts, cookies, fondant, pet treats and so much more!

Just as durable and well made as their free standing counterpart, **Empire Easy Table Top Dough Sheeters** feature a compact design and rugged construction that will ensure years of trouble-free performance. Large diameter rollers and significant dough capacity provide consistent, high quality production. The easy-to-read thickness gauge and lever operated reversing arm are easy to use and allow for precise control, and removable polyethylene scrapers make cleaning a snap! With all of its benefits, it's easy to see why an **Empire Easy Table Top Dough Sheeter** is the must-have tool for your bakery.

Features

- ◆ Fold-Up Side Tables for Easy Storage.
- ◆ Wide, 19 3/4" Synthetic Fabric Sheeting Belts.
- ◆ 11-14 lb. Sheeting Capacity .
- ◆ Great for Sheeting Any Kind of Laminated Dough, Fondant, Pie Crust and more.
- ◆ Maximum Roller Opening - 1 1/2"
- ◆ 3 3/8" Diameter Sheeting Rollers
- ◆ Removable Dough Scrapers are Easy-to-Clean.
- ◆ Safety Guards Provide Enhanced Protection.
- ◆ Rolling Pins and Supports Included.
- ◆ Electrical Requirements:
110V/60Hz/1Ph, 5Amps.
- ◆ Net Weight - 398 lbs.

Technical Data

TABLE TOP SHEETERS EMP-EASY

Model	Working Dimensions (Open)			Stored Dimensions (Folded)			Belt Width	Roller Opening	Electrical		Weight
	Length (A)	Depth	Height	Length	Depth	Height (B)			Connection	Power	
	in	in	in	in	in	in	in	in	V/Hz/Ph	Amps	lbs.
EMP-Easy600	49.2	37.8	25.6	23.2	37.8	29.0	19.7	1.5	110 / 60 / 1	5	378
EMP-Easy750	59.8	37.8	25.6	23.2	37.8	35.0	19.7	1.5	110 / 60 / 1	5	398

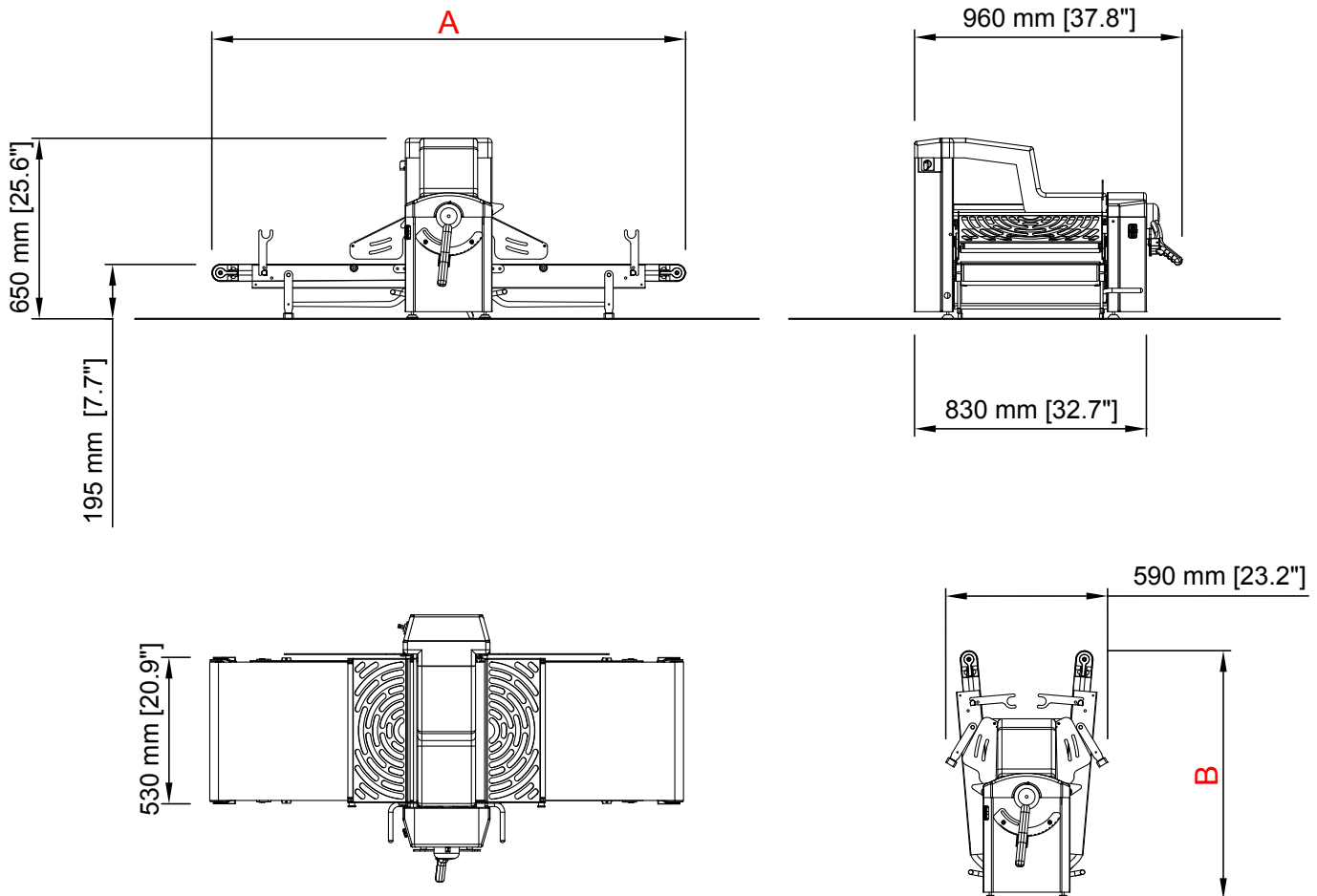

LIMITED WARRANTY

This product is warranted to the original purchaser to be free from material and workmanship defects. This warranty extends for a period of one (1) year from the date of purchase on parts and labor and 90 days on electrical components. For additional information or if you have any questions, please do not hesitate to contact us toll free at 1-800-878-4070.

Please note: It is our policy to continually improve our equipment. Therefore, we reserve the right to change specifications and/or design without notice.



1C Enterprise Place, Hicksville, NY 11801-5356 ♦ Ph: (516) 681-1500 ♦ Fx: (516) 681-1510
 1-800-878-4070 ♦ www.empirebake.com ♦ info@empirebake.com